

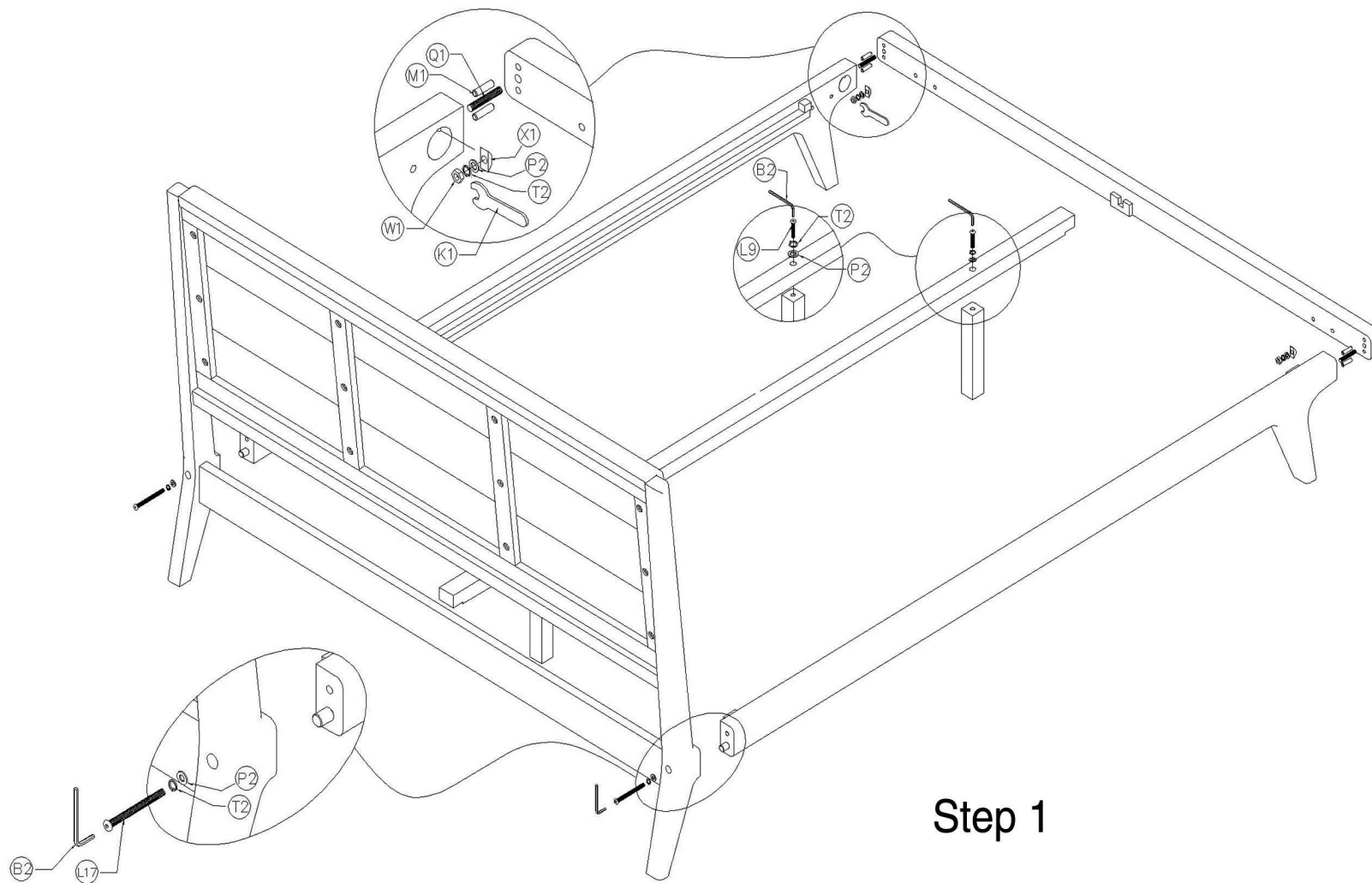













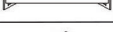

Assembly Instruction



Step 1

Q1		Φ5/16x70mm 2 PCS
L17		Φ5/16x90mm 2 PCS
L9		Φ5/16x55mm 2 PCS
L15		Φ1/4x16mm 16 PCS
B2		5mm 1PC
B1		4mm 1PC
K1		12# 1PC
J1		240x75x30 4 PCS
M1		Φ8 x 30 4 PCS
P2		Φ5/16x16x1.5T 6 PCS
T2		Φ5/16x13x1.5T 6 PCS
P1		Φ1/4x12x1.5T 16 PCS
T1		Φ1/4x11x1.5T 16 PCS
X1		R20 2 PCS
W1		Φ 5/16 2 PCS
●		

Assembly Instruction

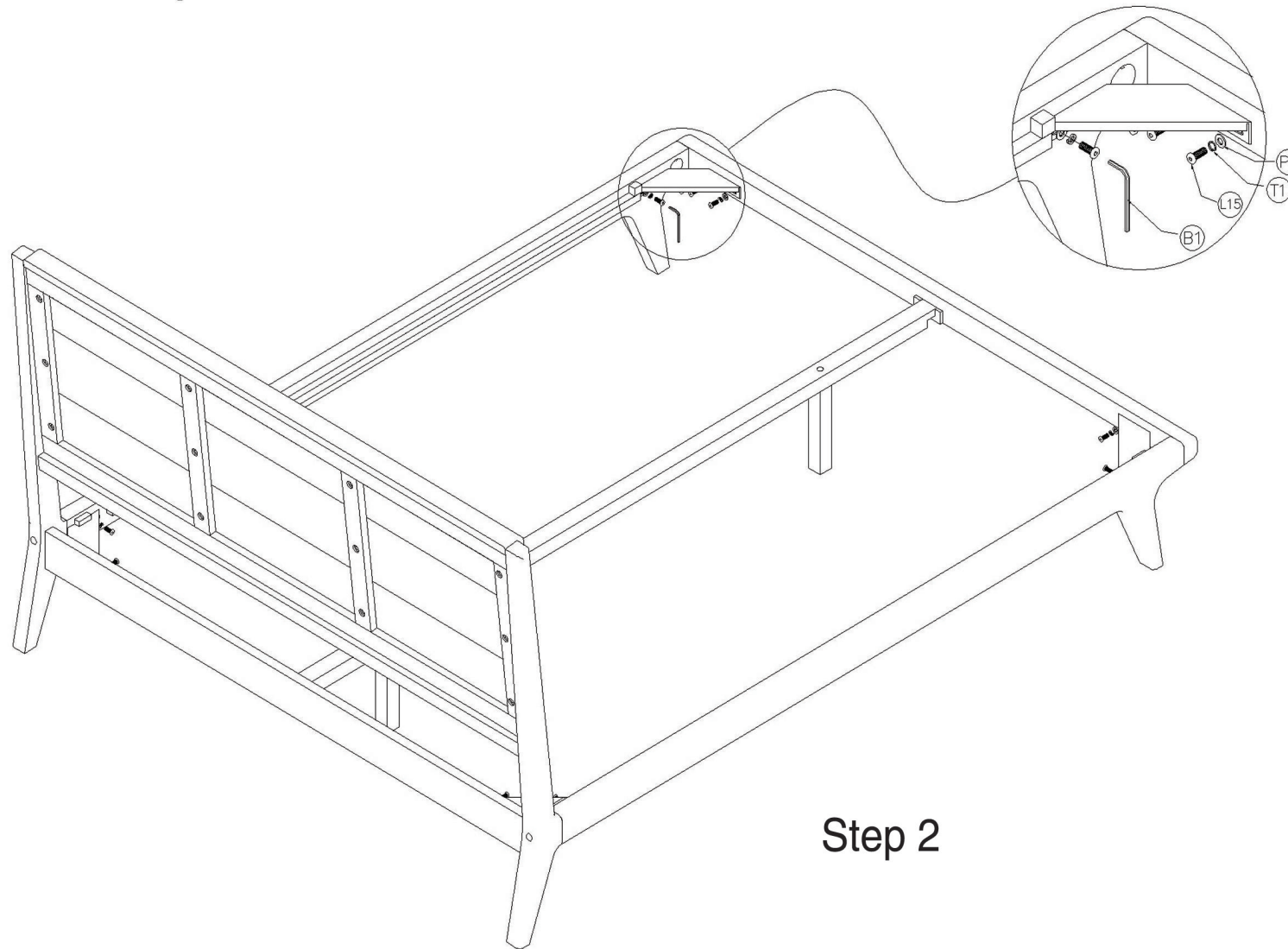







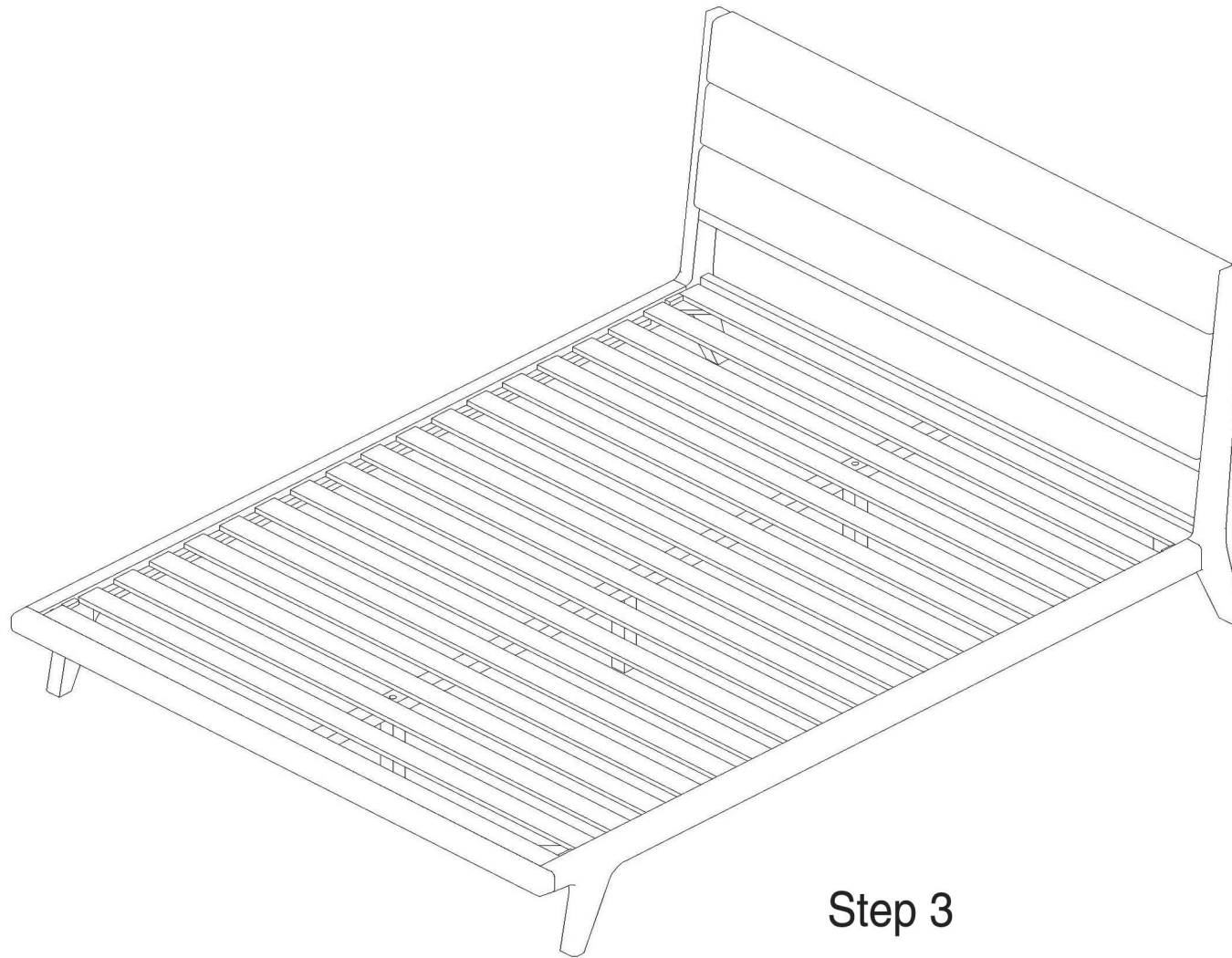







Step 2

Q1		Φ5/16x70mm 2 PCS
L17		Φ5/16x90mm 2 PCS
L9		Φ5/16x55mm 2 PCS
L15		Φ1/4x16mm 16 PCS
B2		5mm 1PC
B1		4mm 1PC
K1		12# 1PC
J1		240x75x30 4 PCS
M1		Φ8 x 30 4 PCS
P2		Φ5/16x16x1.5T 6 PCS
T2		Φ5/16x13x1.5T 6 PCS
P1		Φ1/4x12x1.5T 16 PCS
T1		Φ1/4x11x1.5T 16 PCS
X1		R20 2 PCS
W1		Φ 5/16 2 PCS
●		

Assembly Instruction



Q1		Φ5/16x70mm 2 PCS
L17		Φ5/16x90mm 2 PCS
L9		Φ5/16x55mm 2 PCS
L15		Φ1/4x16mm 16 PCS
B2		5mm 1PC
B1		4mm 1PC
K1		12# 1PC
J1		240x75x30 4 PCS
M1		Φ8 x 30 4 PCS
P2		Φ5/16x16x1.5T 6 PCS
T2		Φ5/16x13x1.5T 6 PCS
P1		Φ1/4x12x1.5T 16 PCS
T1		Φ1/4x11x1.5T 16 PCS
X1		R20 2 PCS
W1		Φ 5/16 2 PCS
●		